

OFFICE Downstairs
 Residence Up stairs
 OWNER BUILDER
 SANDY MOOERS
 541-905-2827
 Designer
 MARK KURZMAL
 CONTACT 541-729-3211
 JOB SITE
 305 MAIN St.
 Brownsville

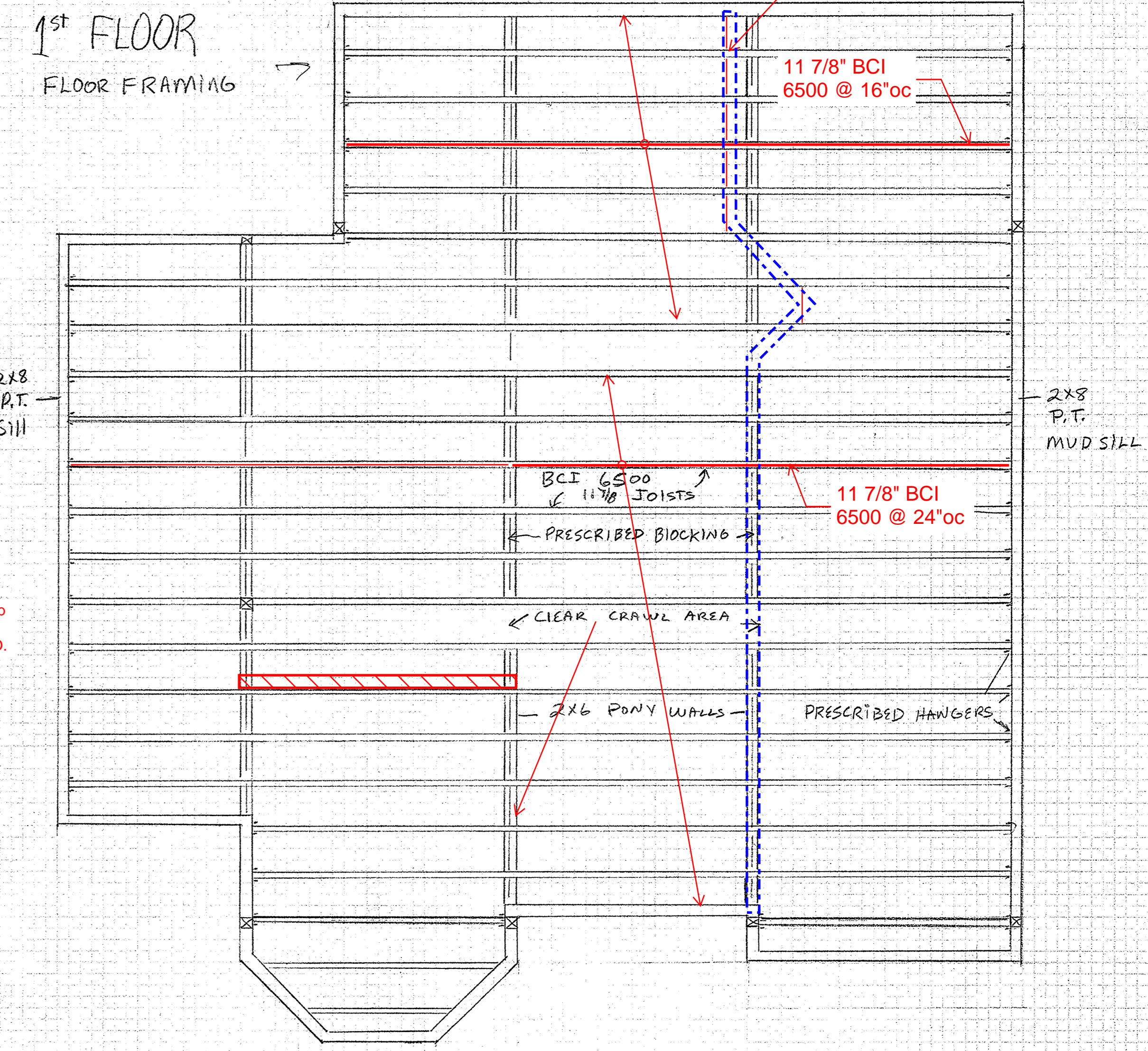

SOUTH SIDE ELEVATION

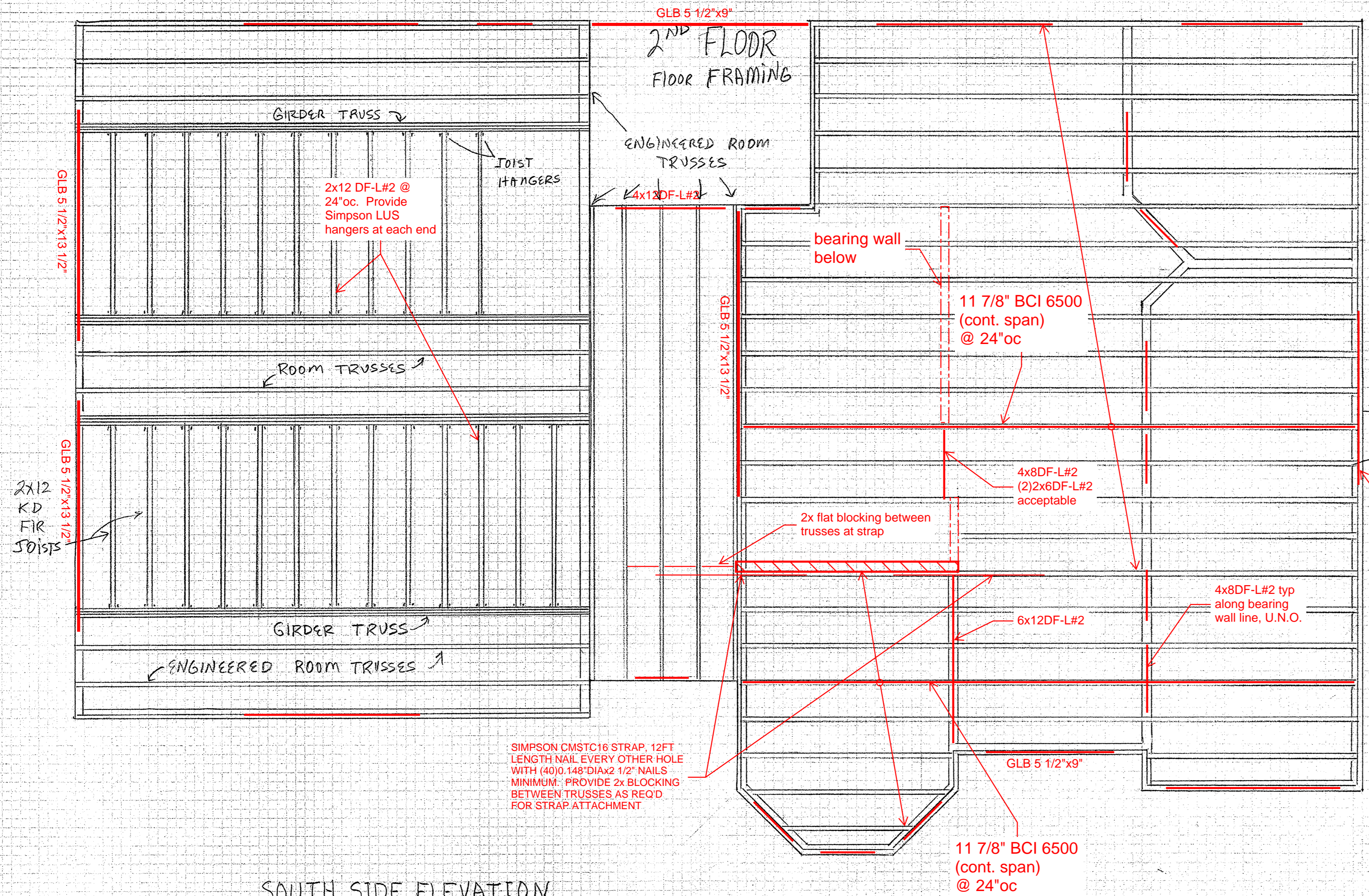

NORTH SIDE ELEVATION

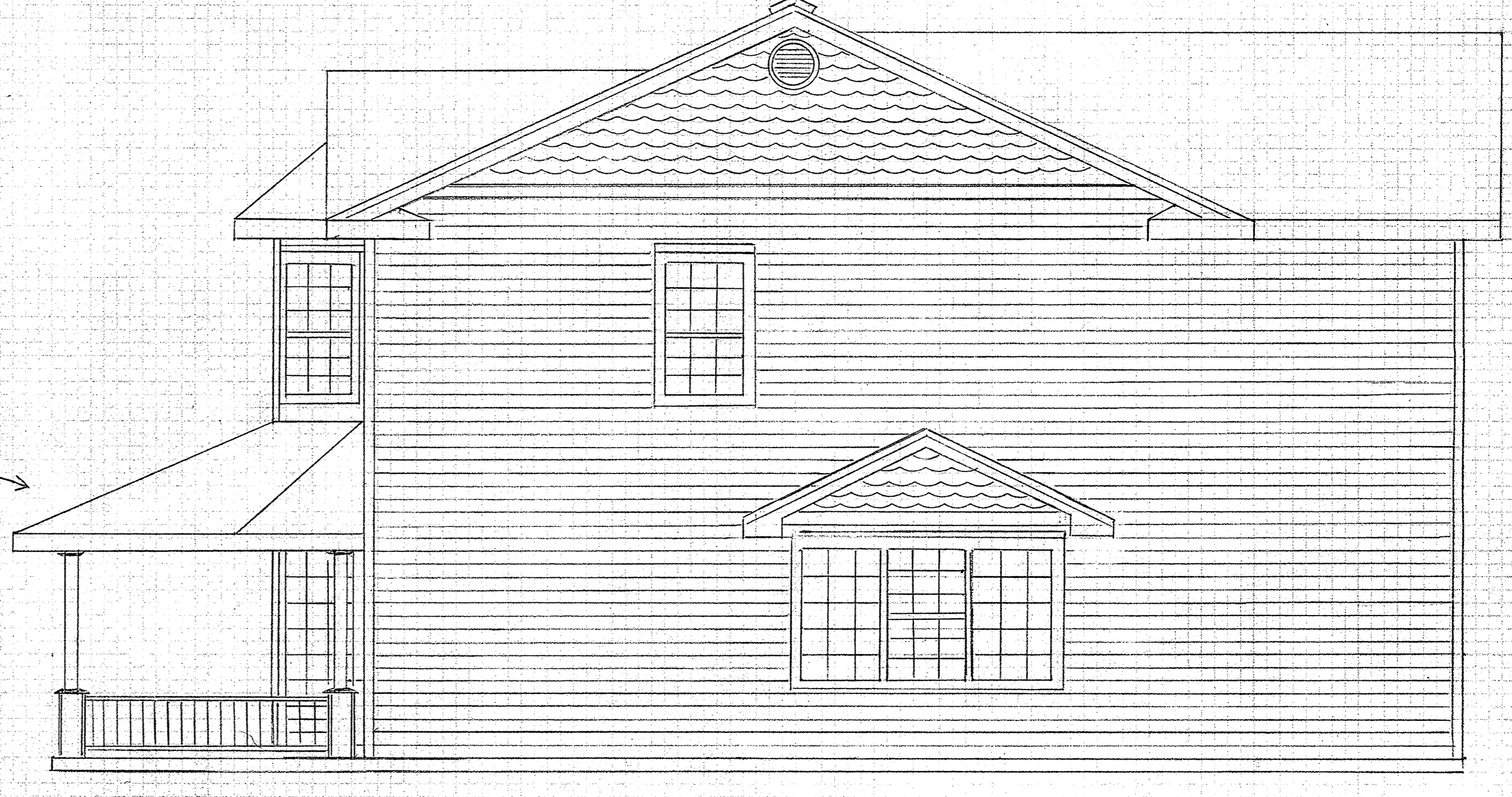

FRONTS

1ST FLOOR

EXISTING RETAINING WALL

PATIO STAMPED CONCRETE

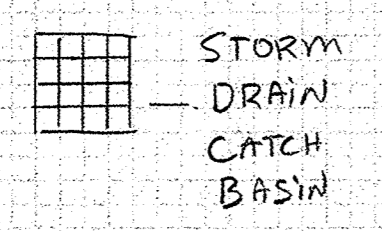
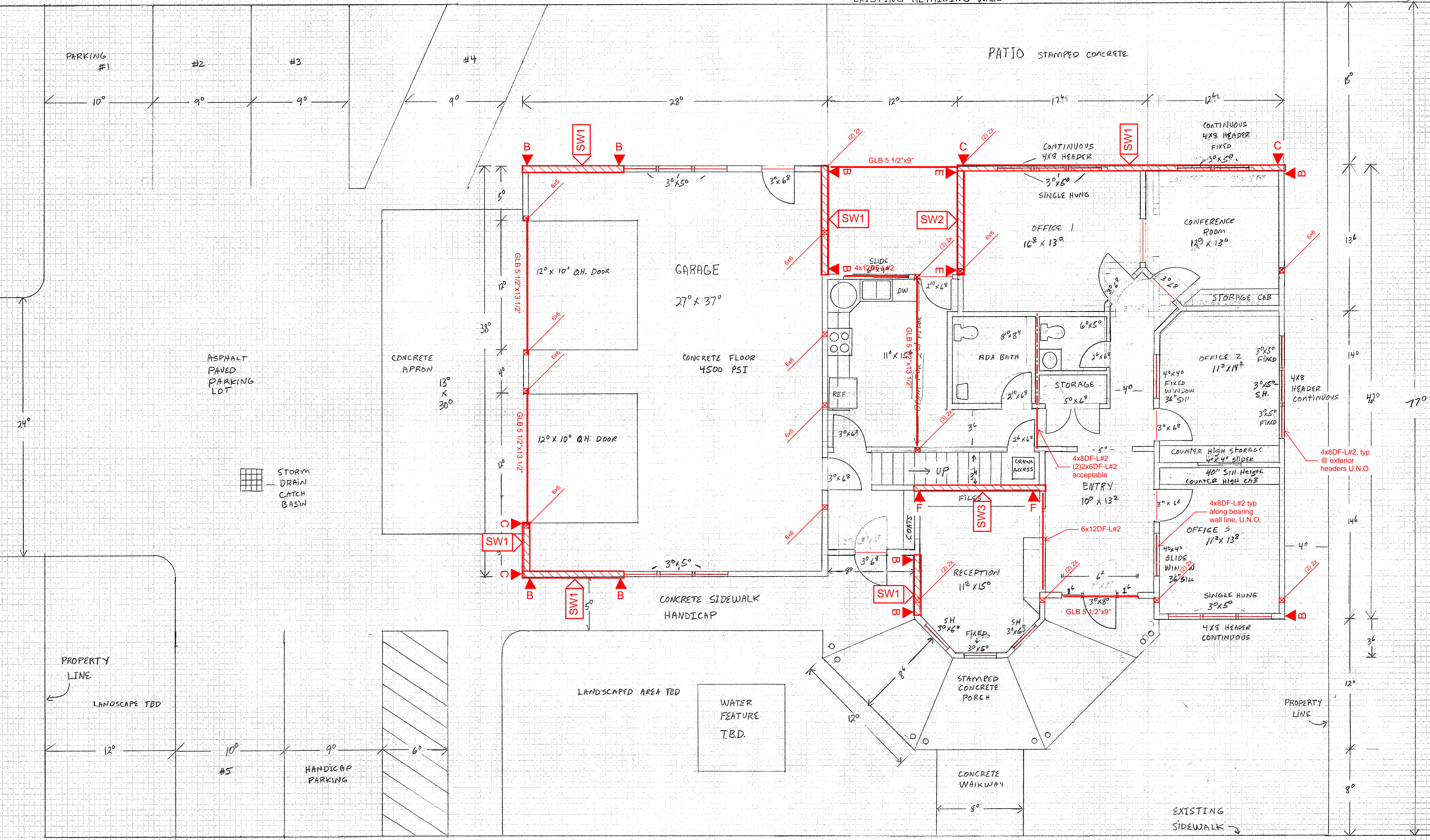

LANDSCAPED AREA TBD
WATER FEATURE T.B.D.

2ND FLOOR

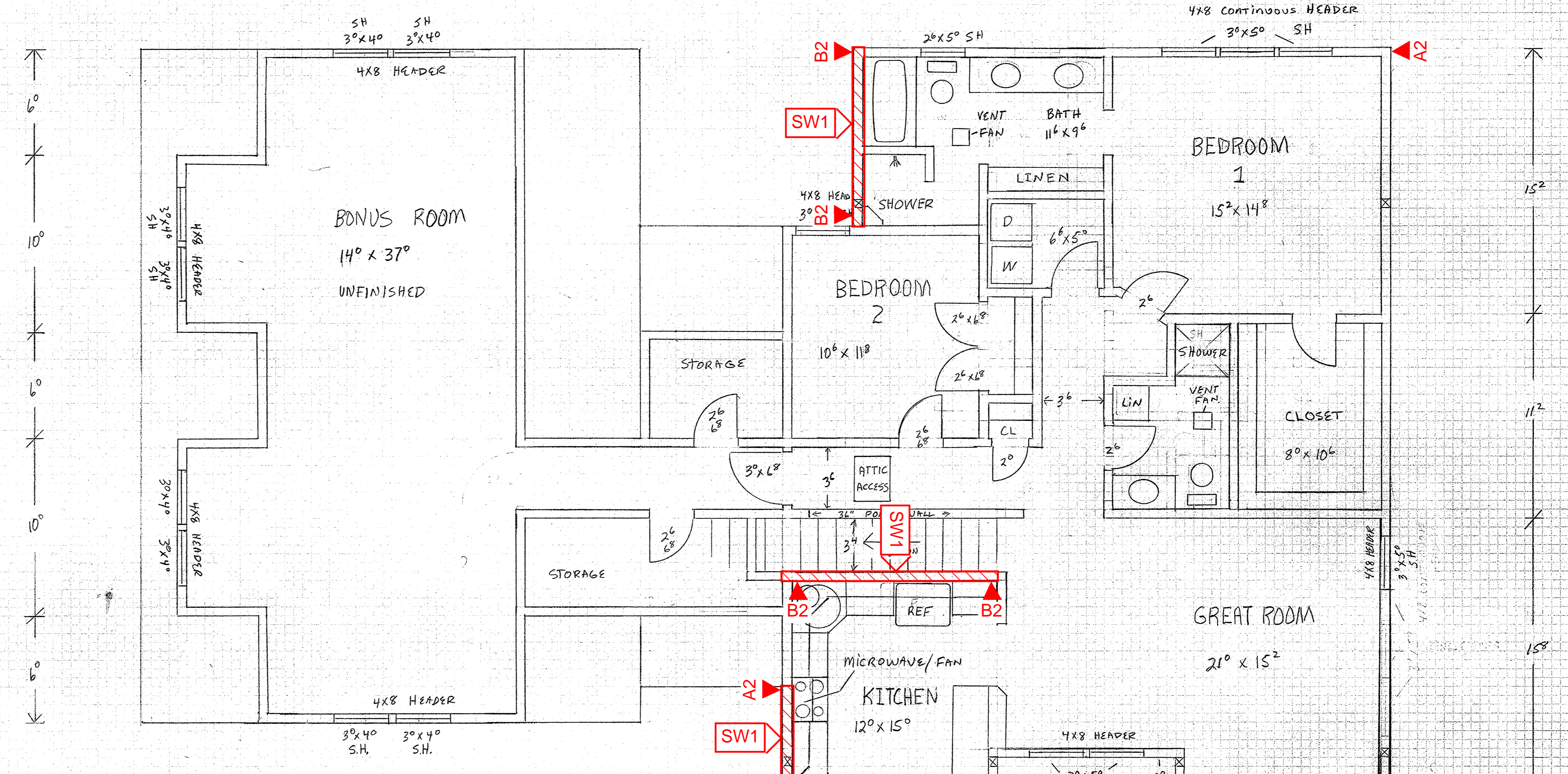
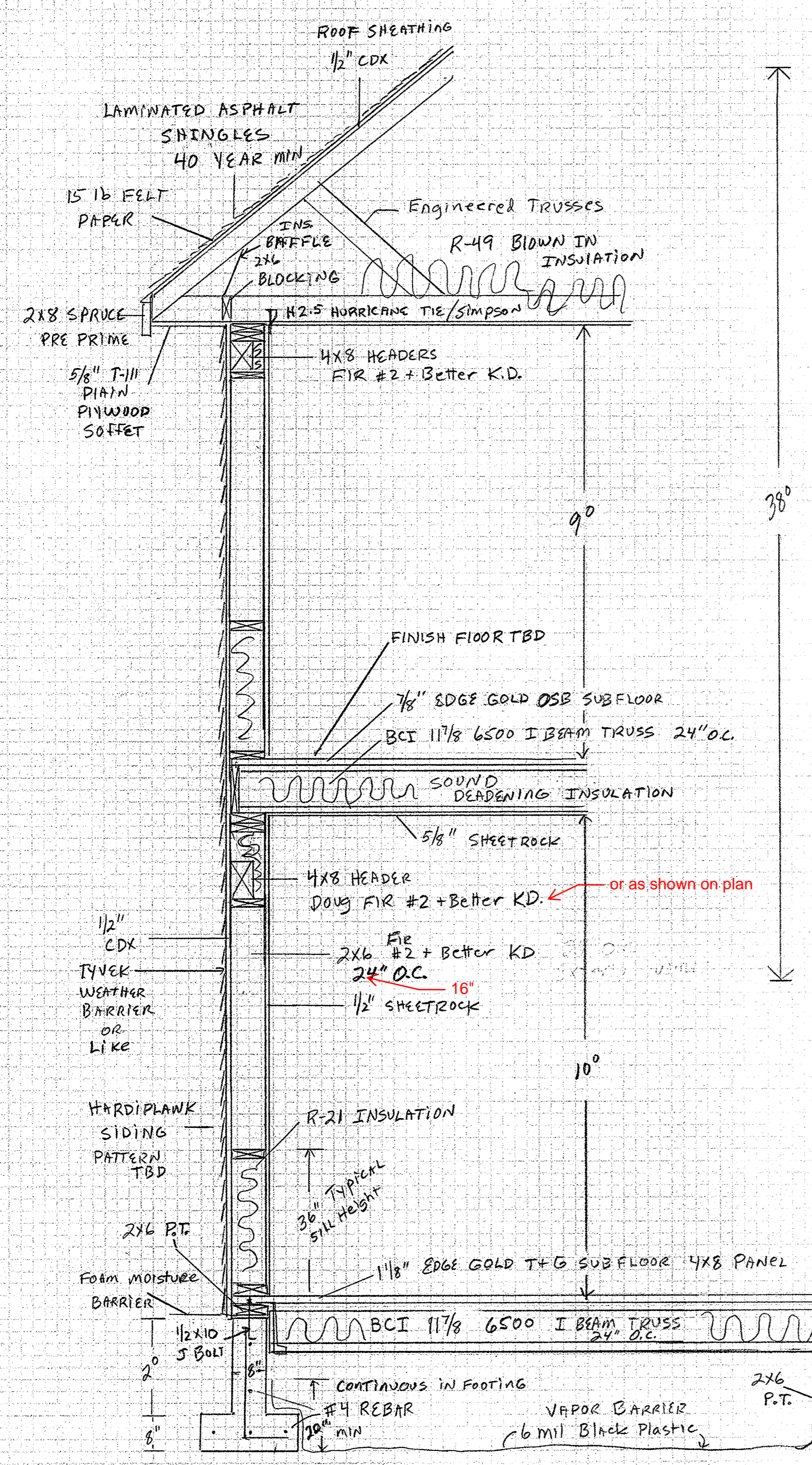
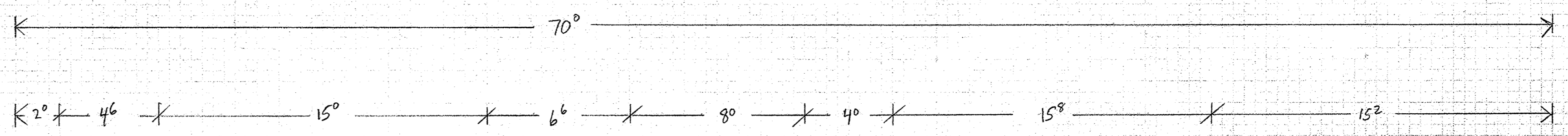

INTERIOR WALLS
 2x4 #2 + BETTER KD
 16" O.C. w/ 4x8 HEADERS OVER ALL DOORS
 ADVANCED FRAMING THROUGHOUT STRUCTURE
 BUILDING CORNER T INTERSECTION WALL BACKER

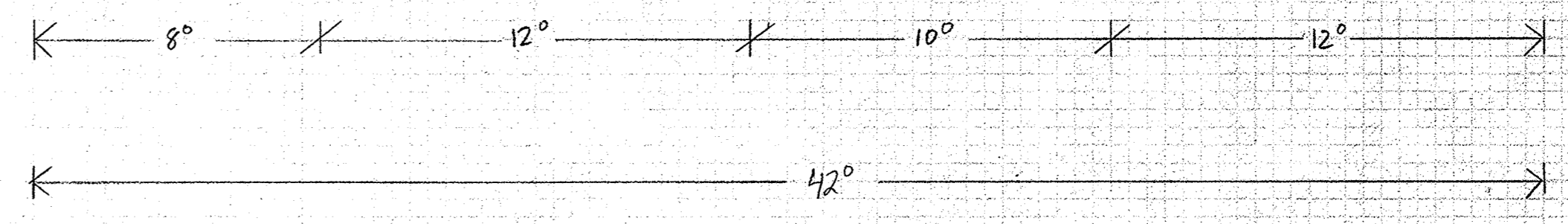

2' 15'

ENGINEERED SHEAR WALL SCHEDULE

- GENERAL NOTES:**
- ALL SHEAR WALLS PANELS SHALL NOT BE LESS THAN 4x8, EXCEPT AT BOUNDARIES AND CHANGES IN FRAMING. PANEL EDGES SHALL LAND ON FRAMING MEMBERS OR BLOCKING WITH ALL EDGES FASTENED PER THE SHEAR WALL SCHEDULE.
 - ALL NAILS REFERENCED IN THE SHEAR WALL SCHEDULE SHALL BE OF THE FOLLOWING TYPES AND MINIMUM SIZES: 8d COMMON (2"x 0.131") OR GALVANIZED BOX (2 1/2" x 0.113"); 10d COMMON (3" x 0.148") OR GALVANIZED BOX (3" x 0.128")
 - LOCATE NAILS AT LEAST 1/4" FROM EDGES AND ENDS OF PANELS AND MEMBERS AS WELL AS BETWEEN ROWS.
 - ALL SHEATHING SHALL LAP ONTO AND BE "EDGE NAILED" TO ALL BOUNDARY MEMBERS WITH ATTACHED HOLD-DOWNS.
 - FOUNDATION ANCHOR BOLTS SHALL HAVE A STEEL PLATE WASHER UNDER EACH NUT NOT LESS THAN 6.225" x 3" x 3" IN SIZE. THE HOLE IN THE PLATE WASHER SHALL BE PERMITTED TO HAVE A 1 1/2" LONG DIAGONAL SLOT WITH A WIDTH OF UP TO 1/4" LARGER THAN THE BOLT DIAMETER, PROVIDED A STANDARD CUT WASHER IS PLACED BETWEEN THE PLATE WASHER AND THE NUT. THE PLATE WASHER SHALL EXTEND TO WITHIN 1/2" OF THE EDGE OF THE BOTTOM PLATE ON THE SIDE(S) WITH SHEATHING.
 - IN SEISMIC DESIGN CATEGORY D, E, OR F, WHERE THE SHEAR WALL IS A TYPE 2 OR GREATER, ALL FRAMING MEMBERS RECEIVING EDGE NAILING FROM ADJUTING PANELS SHALL NOT BE LESS THAN A SINGLE 3-INCH NOMINAL MEMBER OR TWO 2-INCH NOMINAL MEMBERS FASTENED TOGETHER PER THE SCHEDULE BELOW. WOOD STRUCTURAL PANEL JOINT AND SILL PLATE NAILING SHALL BE STAGGERED AT ALL PANEL EDGES.

TYPE	OSB / PLYWOOD SHEATHING	FASTENING: SHEATHING TO STUDS		MUD SILL A.B. SIZE & SPACING	RIM JOISTS TO PLATE BELOW #5	PLATE TO RIM JOIST BELOW #8	TRUSS / RAFTER BLOCKING TO TOP PLATE U.N.O.	DBL. STUD FASTENING
		EDGES	FIELD					
SWS	7/8" GWB SEE NOTE 5	NO. 6 TYPE S OR W DRYWALL SCREWS 8" OC	12" OC	1/2" @ 72" OC		16d @ 16" OC	(3) 8d TOE-NAIL EA. BAY	
SW1	1 SIDE	8d @ 6" OC	8d @ 12" OC	1/2" @ 48" OC	SIMPSON LTP4 @ 48" OC	16d @ 6" OC	TIMBERLOK TO TRUSS AND SIMPSON L50 @ 24" OC ON BLOCKING	(1) ROW 16d @ 12" OC
SW2	1 SIDE	8d @ 4" OC	8d @ 12" OC	1/2" @ 32" OC 1/2" @ 48" OC	SIMPSON LTP4 @ 32" OC	16d @ 6" OC & SIMPSON LTP4 @ 48" OC	TIMBERLOK TO TRUSS AND SIMPSON L50 @ 15" OC ON BLOCKING	(2) ROWS 16d @ 10" OC
SW3	1 SIDE	8d @ 3" OC	8d @ 12" OC	1/2" @ 24" OC 1/2" @ 32" OC	SIMPSON LTP4 @ 24" OC	16d @ 6" OC & SIMPSON LTP4 @ 24" OC	TIMBERLOK TO TRUSS AND SIMPSON L50 @ 10" OC ON BLOCKING	(2) ROWS 16d @ 8" OC
SW4	1 SIDE	8d @ 2" OC SEE NOTE 2	8d @ 12" OC	1/2" @ 16" OC 1/2" @ 24" OC	SIMPSON LTP4 @ 16" OC	16d @ 6" OC & SIMPSON LTP4 @ 16" OC	SIMPSON HT10A TO TRUSS AND L50 @ 8" OC ON BLOCKING	(2) ROWS 16d @ 6" OC

- NOTES:**
- PLYWOOD OR OSB SHEATHING 3/8" THICK SHALL BE USED AS SHOWN IN THIS TABLE. 1/2" THICK SHEATHING MAY BE SUBSTITUTED PROVIDED STUDS ARE SPACED A MAXIMUM OF 16" OC OR PANELS ARE APPLIED WITH LONG DIMENSIONS ACROSS STUDS.
 - FRAMING AT ADJOINING PANELS EDGES SHALL BE 3" NOMINAL OR WIDER, AND NAILS SHALL BE STAGGERED WHERE NAILS ARE SPACED 2" OC.
 - FRAMING AT ADJOINING PANEL EDGES SHALL BE 3" NOMINAL OR WIDER, AND NAILS SHALL BE STAGGERED.
 - WHERE PANELS ARE APPLIED TO BOTH FACES OF A WALL AND THE NAIL SPACING IS LESS THAN 6" OC ON EITHER SIDE, PANEL JOINTS SHALL BE OFFSET TO FALL ON DIFFERENT FRAMING MEMBERS, OR FRAMING SHALL BE 3" NOMINAL OR THICKER AT ADJOINING PANEL EDGES AND NAILS SHALL BE STAGGERED.
 - MAXIMUM STUD SPACING IS 16" OC. BLOCKING AT PANEL EDGES IS NOT REQUIRED.
 - CONNECTORS ARE IN ADDITION TO THE MINIMUM CODE NAILING REQUIREMENT (8d TOE-NAIL @ 6" OC) UNLESS OTHERWISE SPECIFIED IN THE DETAILS.
 - THE CONTRACTOR SHALL VERIFY THAT THE SUPPLIED RIM BOARD IS COMPATIBLE WITH THE SPECIFIED NAILING REQUIREMENTS. FOR 1/2" RIM BOARD W/ MAX 3/4" SHEATHING SUBSTITUTE (2) ROWS 16d SINKER (0.148 x 3/4") @ 8" OC OFFSET ROWS 1/2" MIN AND STAGGER.
 - SIMPSON LTP4 CLIPS MAY BE OMITTED FROM THESE LOCATIONS PROVIDED THAT SHEATHING JOINT OCCURS ON THE RIM JOIST WITH A MINIMUM 2 1/2" LAP. SHEATHING SHALL BE FASTENED TO RIM JOIST, TOP PLATE AND BOTTOM PLATE WITH EDGE NAILING PER SHEAR WALL SCHEDULE REGARDLESS WHETHER THEY OCCUR AT EDGES.
 - UNLESS OTHERWISE NOTED ON THE DRAWINGS PROVIDE THE SPECIFIED FASTENERS FOR THE LENGTH OF THE PLATE LINE (NOT JUST THE SHEAR WALL SEGMENT). ADDITIONAL FASTENERS, STRAPS, PLATE SPLICE REQUIREMENTS, ETC. MAY BE NOTED ON THE PLANS AND DETAILS.

HOLD-DOWN SCHEDULE

HOLD-DOWN TYPE		ANCHOR BOLT			BOUNDARY MEMBER POST & FASTENING	
TYPE	SIMPSON CALLOUT	ANCHOR U.N.O.	MIN. EMBEDMENT	MIN. STEM WALL WIDTH	HOLD-DOWN FASTENING TO POST	MIN. POST SIZE, NUMBER & FASTENING OF BUILT UP POSTS
A	DTTZ	1/2" HOOKED ANCHOR	7" W/ 12" MIN. EDGE DISTANCE	6"	(6) SDS 1/2"x1/2" SCREWS	(1) 2x WALL DEPTH STUD
A2	LSTA36	N.A.	N.A.	N.A.	(7) 10d COMMON EA END OF STRAP	(1) 2x WALL DEPTH STUD
B	HDU2	SIMPSON SSTB16	12 1/2"	6"	(6) SDS 1/2"x2 1/2" SCREWS	(2) 2x WALL DEPTH STUD, FASTEN TOGETHER W/ (12) 16d SINKERS
B2	MSTC 40	N.A.	N.A.	N.A.	(14) 10d COMMON EA END OF STRAP	(2) 2x WALL DEPTH STUD, FASTEN TOGETHER W/ (18) 16d SINKERS
C	HDU4-SDS	SIMPSON SB 3/4x24	18"	6"	(10) SDS 1/2"x2 1/2" SCREWS	(2) 2x WALL DEPTH STUD, FASTEN TOGETHER W/ (18) 16d SINKERS
C2	MSTC 52	N.A.	N.A.	N.A.	(22) 10d COMMON EA END OF STRAP	(2) 2x WALL DEPTH STUD, FASTEN TOGETHER W/ (18) 16d SINKERS
D	HOU5-SDS	SIMPSON SB 3/4x24	18"	6"	(14) SDS 1/2"x2 1/2" SCREWS	(2) 2x WALL DEPTH STUD, FASTEN TOGETHER W/ (24) 16d SINKERS
D2	MSTC 66	N.A.	N.A.	N.A.	(32) 10d COMMON EA END OF STRAP	(2) 2x WALL DEPTH STUD, FASTEN TOGETHER W/ (24) 16d SINKERS
E	HOU8-SDS	SIMPSON SB 3/4x24	18"	8"	(20) SDS 1/2"x2 1/2" SCREWS	(1) 4x4 OR (3) 2x4
F	HOU11-SDS	SIMPSON SB 1x30	24"	8"	(30) SDS 1/2"x2 1/2" SCREWS	(1) 5 1/2"x3 1/2" OR (1) 7 1/2"x3 1/2" AS NOTED ON PLAN
G	HOU14-SDS	1" Ø PER PLANS	PER PLANS	PER PLANS	(36) SDS 1/2"x2 1/2" SCREWS	(1) 6x6 MIN.

- NOTES:**
- FASTEN HOLD-DOWNS TO THE BOUNDARY MEMBERS FOR THE SHEAR WALL AT THE LOCATIONS MARKED ON THE PLANS.
 - SHEAR WALL PANELS SHALL BE FASTENED TO THE BOUNDARY MEMBER POSTS PER THE PANEL EDGE SPACING ON THE SHEAR WALL SCHEDULE.
 - WHERE BOUNDARY MEMBERS ARE BUILT UP MEMBERS OR OVER 2" NOMINAL, EDGE NAILING SHALL BE STAGGERED INTO TWO ROWS.
 - ALL HOLD-DOWNS AND ANCHOR BOLTS SHALL BE INSTALLED PER THE MANUFACTURERS INSTRUCTIONS.
 - ALL HOLD-DOWNS AND BOUNDARY MEMBER POSTS SHALL BE INSTALLED TO FORM A CONTINUOUS LOAD PATH FROM EACH END OF THE SHEAR WALL TO THE FOUNDATION BELOW.

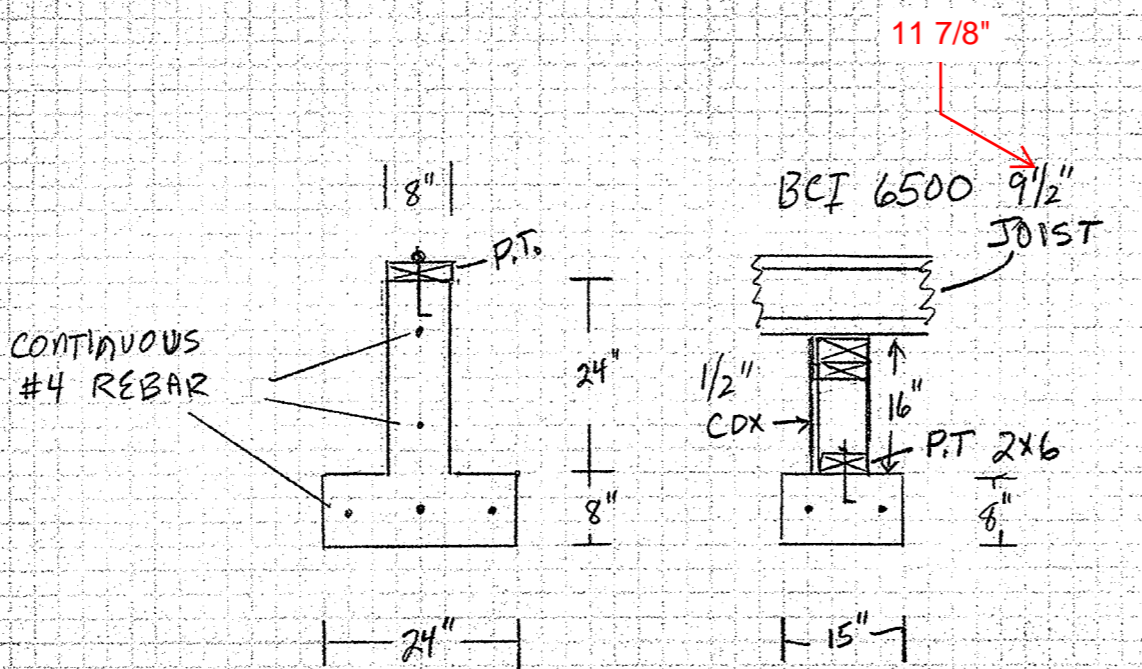
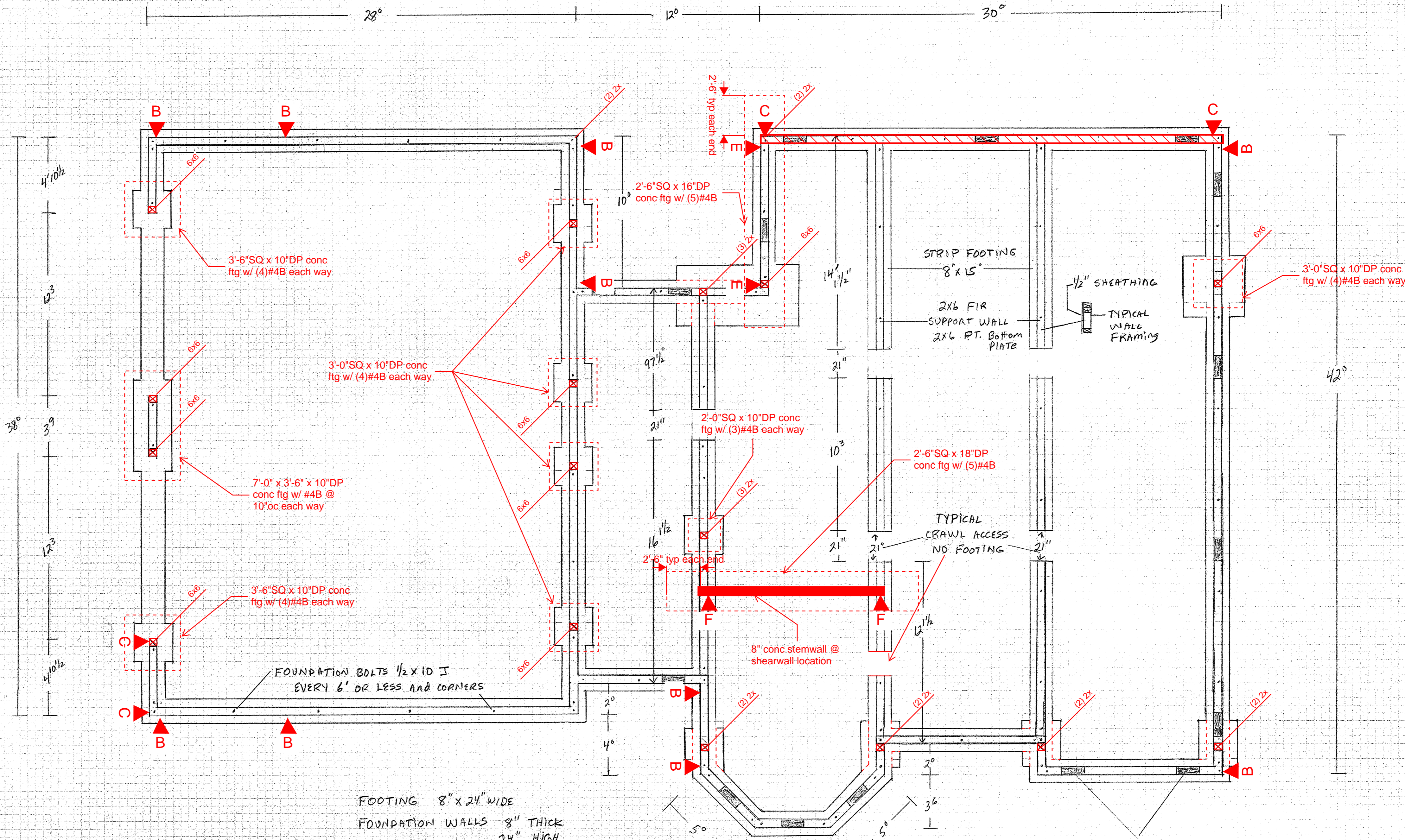

- FOOTING 8" x 24" WIDE
- FOUNDATION WALLS 8" THICK 24" HIGH
- FOUNDATION BOLTS 1/2 x 10 I
- ☒ DENOTE LOAD BEARING POINTS FOR GIRDER TRUSSES
- 8 x 16 FOUNDATION VENTS
- BEARING PADS SIZES TBD BY ENGINEER

FOUNDATION VENTS
 8 x 16
 .73 NFA PER VENT
 1648 SFT of CRAWL SPACE
 ÷ 150
 = 11 SFT x .73 =
 16 VENTS MINIMUM REQUIRED.



